

3 611 C32 185

Issue } 14-05-21
Stand }

Fig./Abb. 2

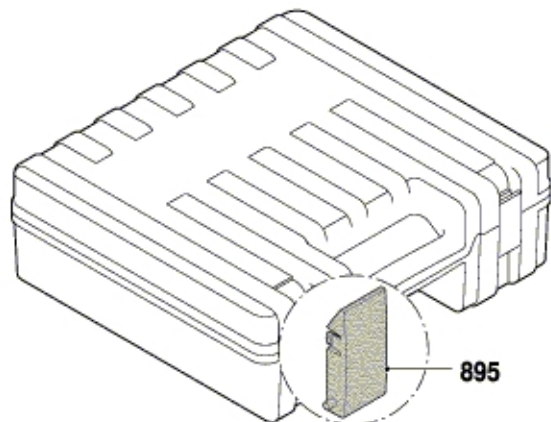
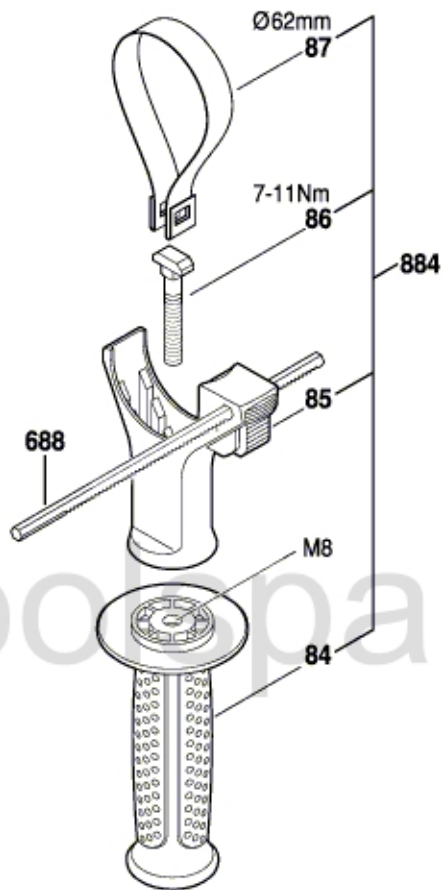

tools4parts.com.au

Änderungen vorbehalten
Modifications reserved
Modifications réservées
Salvo modificaciones